

**DETALLE CORDÓN CUNETA H21**

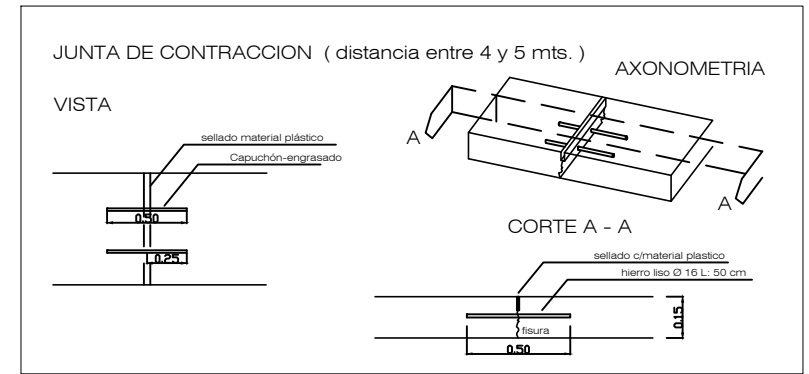

**PERFIL TRANSVERSAL AVENIDA CORDÓN CUNETA**

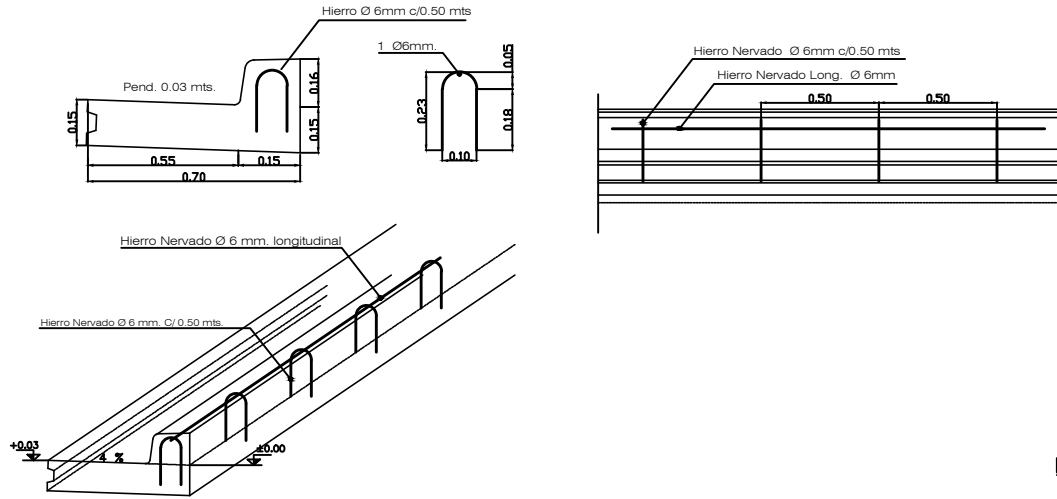
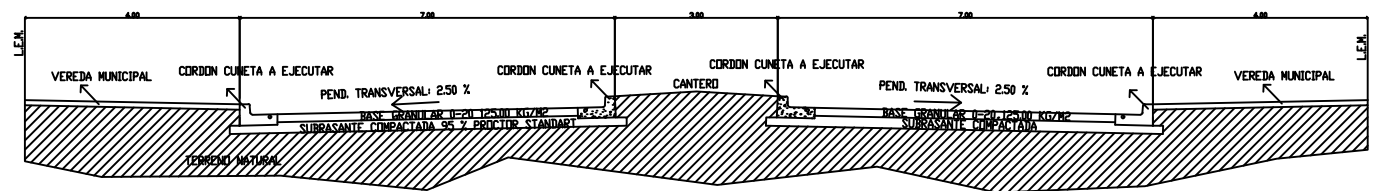

**JUNTA DE EXPANSIÓN en una distancia no mayor a 100 mts**

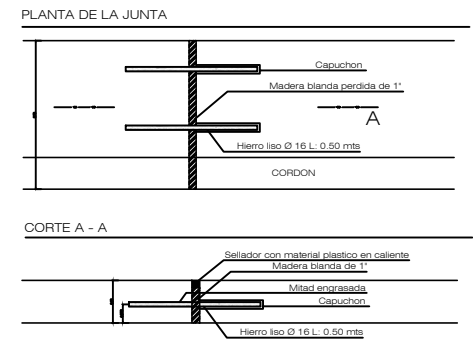

**PERFIL TRANSVERSAL CORDON CUNETA**

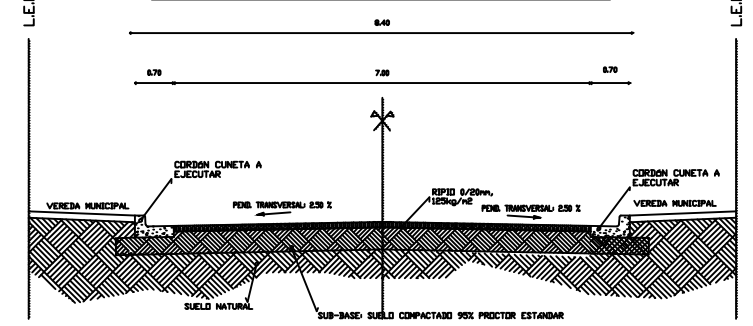

**JUNTA DE EXPANSIÓN en una distancia no mayor a 100 mts**

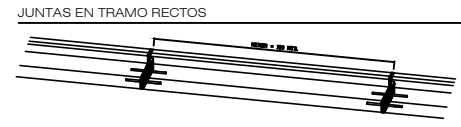

**JUNTAS EN ESQUINA**

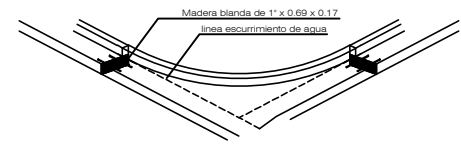

	<p>MUNICIPALIDAD DE SUNCHALES</p> <p>LOTED MUNICIPAL 14 HECTÁREAS</p>		
	<p>INT: Dr. Gonzalo Toselli</p>	<p>Plano: DETALLES CORDÓN CUNETA</p>	
<p>PROYECTO:</p>	<p>DIBUJO:</p>	<p>PLANO Nº16</p> <p>MARZO 2019</p>	